



ME

Extraction arm for laboratory environments with clean design and market-leading low pressure drop



ATEX
COMPATIBLE

FUMEX
PURE ADVANTAGE

With its optimal design, **FUMEX ME** has many valuable advantages:

- Market-leading low pressure drop
- Energy-saving design
- Flexible and positionally stable
- Tight-fitting damper
- Low noise level
- Low risk of disruptive noise
- Easy to combine with other extractors in the same system

Optimal design with low pressure drop offers many advantages

The unique design of the **FUMEX ME** extractor joint structure combines maximum flexibility with a low pressure drop. ME is the optimal local extractor for all types of laboratory environments, hair salons and light industrial applications, such as soldering.

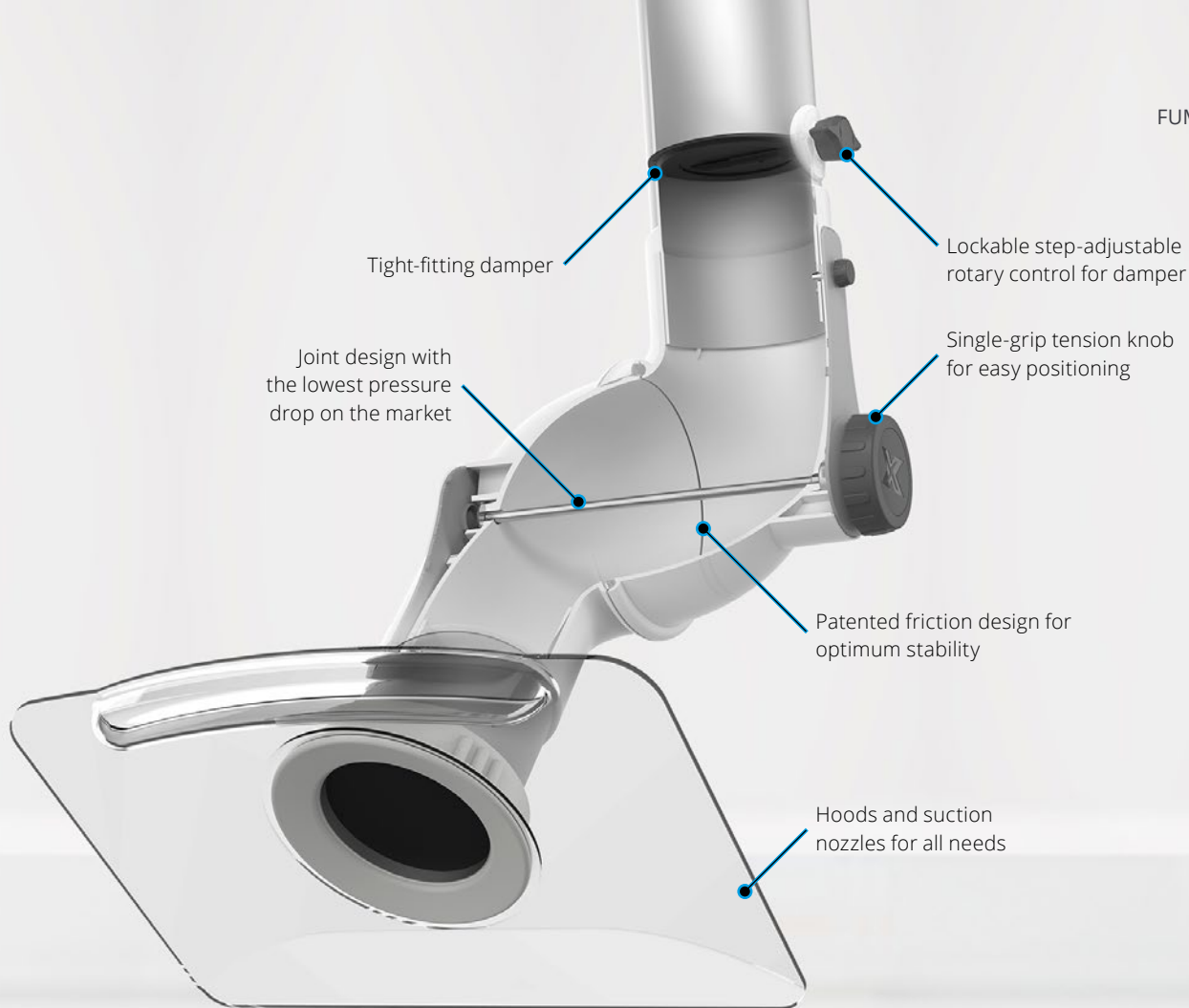

Well thought through and proven design for optimal function

Patented friction design

FUMEX ME's patented friction design gives a positionally stable arm with smooth and flexible function and a market-leading low pressure drop.

User friendly

FUMEX ME is very user friendly and can also be completely folded away from the work area when necessary. The model, which is continuously redesigned and updated, has proven longevity with components built to last.

Hoods and brackets

The ME series has a wide range of hoods and brackets. This gives great flexibility in terms of how the local extractor can be mounted and used, regardless of the room conditions or the nature of the work.

One arm. Endless options.

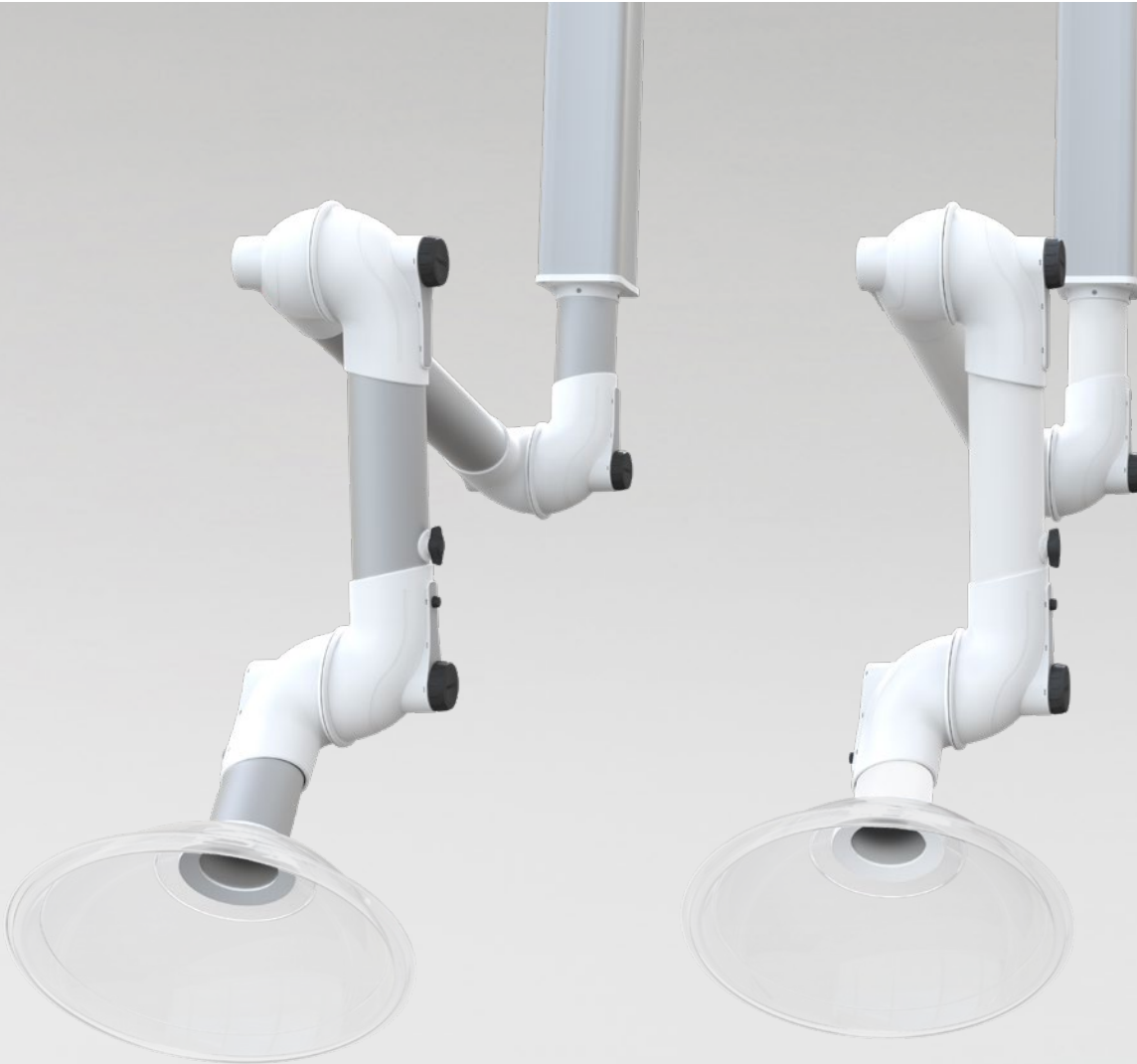

ME STD

Suitable for evacuating most types of airborne contaminants, e.g. in laboratories, schools, hospitals, the pharmaceutical industry, hair salons and light industrial applications.

ME STD has polypropylene joints and thin-wall anodised aluminium tubes.

Available in the dimensions Ø50/75/100 mm.

ME PP

Used primarily for evacuating very corrosive airborne contaminants in high concentrations, e.g. in certain laboratories and in the pharmaceutical and chemical industries.

ME PP has polypropylene joints and tubes. All metal parts that come into contact with the airflow are made of stainless steel. Ceiling bracket MTI for ME PP is available with internal epoxy coating for higher corrosion resistance.

Available in the dimensions Ø75/100 mm.

Choose FUMEX ME for the best combination of accessories for every situation, enabling you to create the optimal local extractor for evacuating hazardous airborne gases and particles.



ME **ESD**

Suitable for evacuating airborne contaminants in environments where there is a need to avoid the risk of spark formation and where products need to be ESD-certified for use, e.g. the electronics industry.

Conductive polypropylene joints and conductive polypropylene (Ø75) or aluminium (Ø50) tubes with earth cables make the entire extractor electrically conductive.

ME ESD is type approved according to EN 61340-5-1.

Available in the dimensions Ø50/75 mm.

ME **ATEX**

Suitable for evacuating airborne contaminants in ATEX-classified environments, e.g. in laboratories, the chemical and petrochemical industries, gas distribution, and the paint- and pharmaceutical industries.

Conductive polypropylene joints and tubes. All metal parts in contact with the airflow are made of stainless steel. All load-bearing metal parts are painted with special conductive paint. The product complies with ATEX Directive 2014/34/EU category 2 for gases and dust.

Available in the dimensions Ø75/100 mm.



What is **your** need?

Three dimensions and three standard brackets for different needs and applications

FUMEX ME is available in the dimensions Ø50/75/100 mm in lengths between 650–2,650 mm. Ceiling/wall/table brackets are available as standard, with ceiling brackets functioning as an exhaust duct. ME facilitates many different types of needs, both in terms of use and installation. For stylish and functional installations, there are extension kits and cover plates as well as a wide range of hoods and suction nozzles. The market's most complete local extractor.

Recommended airflow

ME 50

Suitable for work environments and work requiring relatively small airflows.

Activity	Recommended airflow	
Hair salons	65 m ³ /h	18 l/s
Laboratories	50-75 m ³ /h	15-21 l/s
Schools	50-75 m ³ /h	15-21 l/s

ME 75

A standard solution suitable for most work environments. Suitable where needs vary.

Activity	Recommended airflow	
Laboratories	120-150 m ³ /h	33-42 l/s
Schools	120-150 m ³ /h	33-42 l/s

ME 100

Suitable for work environments and work requiring relatively large airflows.

Activity	Recommended airflow	
Laboratories	200-300 m ³ /h	55-80 l/s
Light industry	300 m ³ /h	80 l/s



Optimal capture

For optimal use of the local extractor, it is important to use the flexibility of the extractor to get as close to the contaminant as possible. A good rule of thumb is a distance of 2-3 times the diameter of the local extractor tube. Then the local extractor (at the recommended airflow) gives a continued high efficiency even when there are disruptions in the environment.

Pressure drop

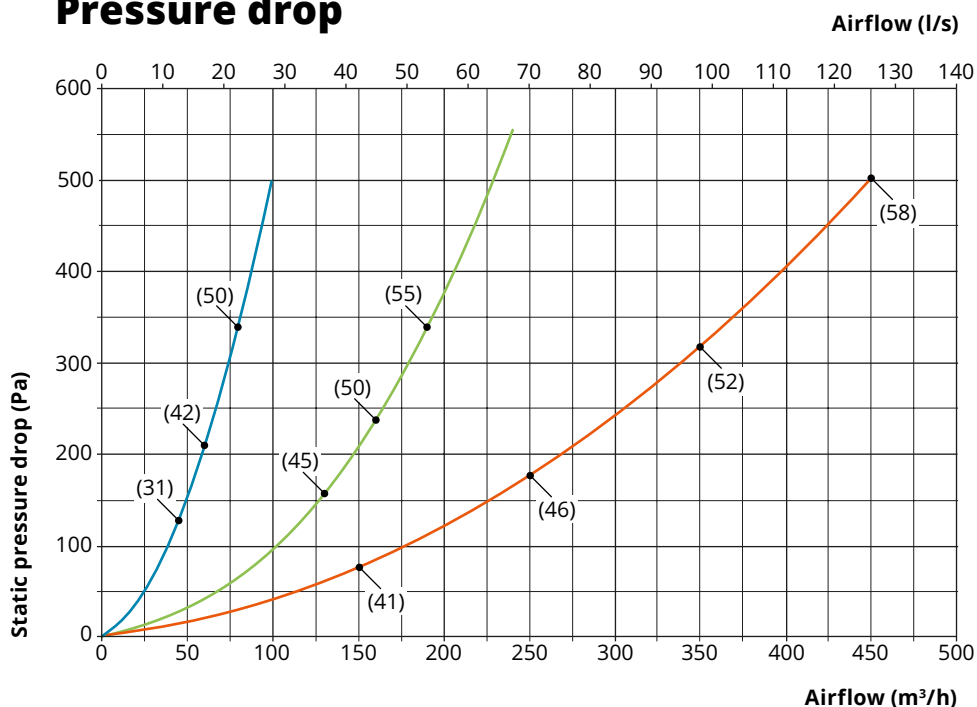

Dimensions (Ø)

- ME-50
 - ME-75
 - ME-100
- (xx) db(A)

Measuring methods

Static pressure drop is measured in accordance with ISO standard 5167-1. Noise level is measured in accordance with ISO standard 3743. Reported sound data refers to sound pressure level.

Support for design

Reach (m)

At the recommended mounting height.

ME 50/75

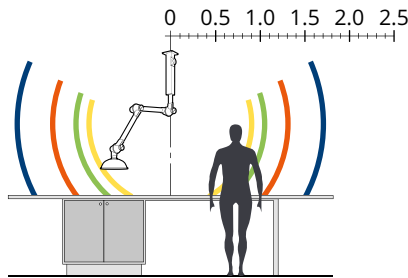
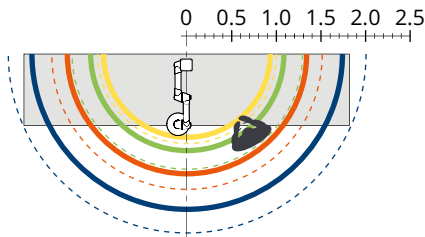

- ME 1000
- ME 1300
- ME 1500
- ME 2000
- Max. working radius
- Max. radius

ME 100

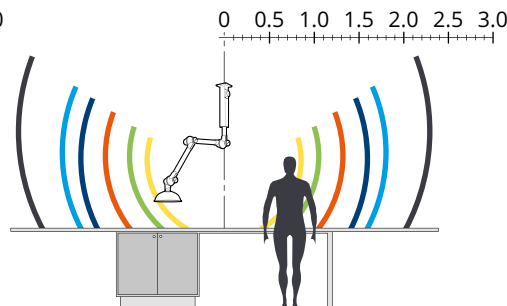
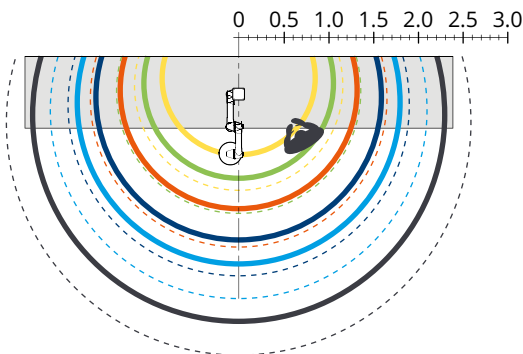

- ME 1150
- ME 1350
- ME 1650
- ME 1900
- ME 2100
- ME 2650
- Max. working radius
- Max. radius

Version			Recommended mounting height (mm)	Recommended side displacement (mm)
Ø50	Ø75	Ø100		
MET 1000	MET 1000		1900	350
		MET 1150	1900	450
MET 1300	MET 1300	MET 1350	2100	550
MET 1500	MET 1500	MET 1650	2200	650
	MET 2000	MET 1900	2400	750
		MET 2100	2400	800
		MET 2650	2400	1000

Mounting height* and side displacement

To optimise the reach of the extractor, the following mounting heights and side displacement are recommended relative to the work area.

*Based on a working height of 900 mm.

Design tool and CAD drawings

Support for designing your unit is available at www.fumex.com. There you will find our reach configurator (Design tool) and CAD drawings for download.

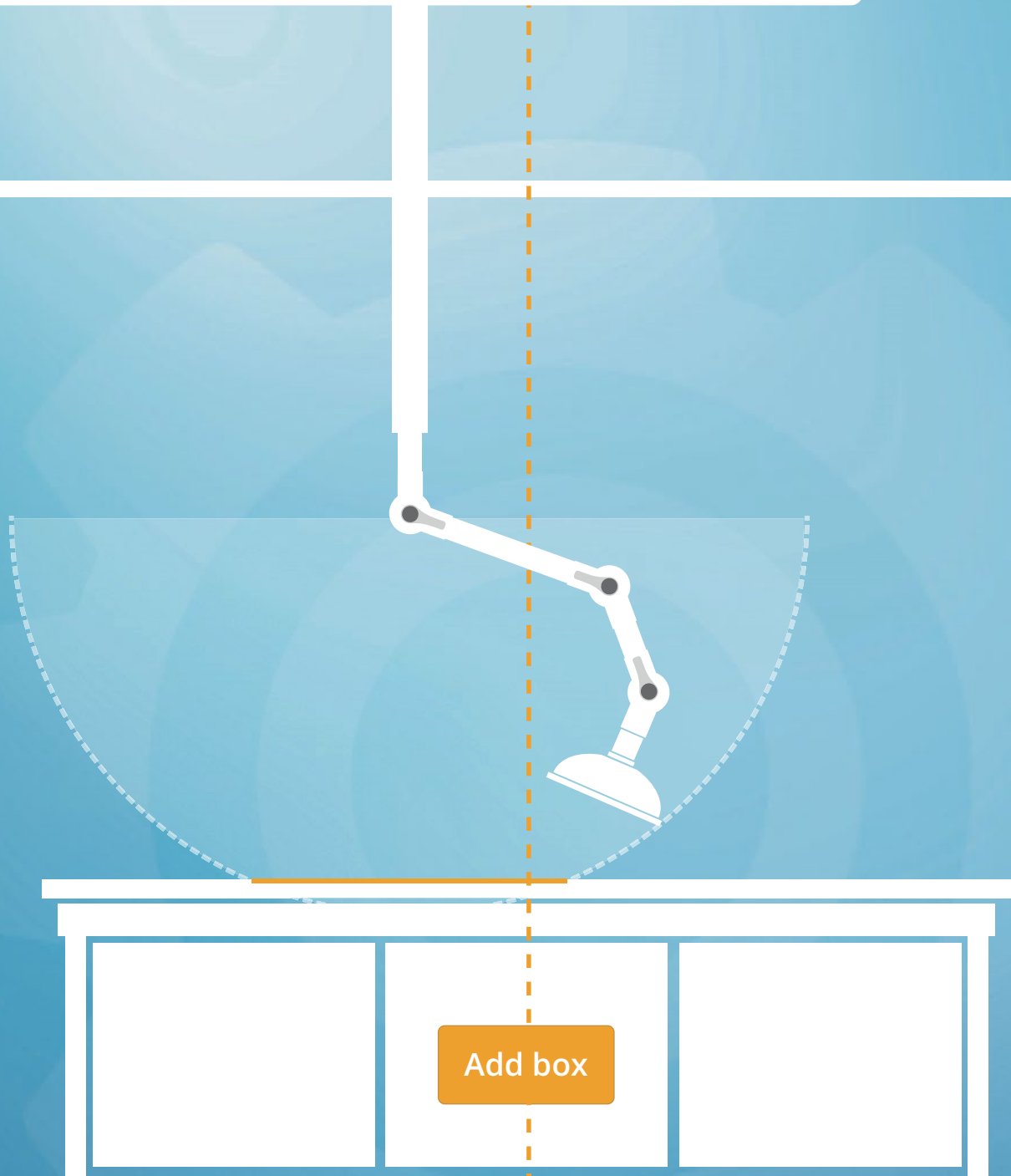

Add box

Version and dimensional drawing

MET (Ceiling/Wall)

With an internal mechanical spring or external gas spring (depending on model), for ceiling and wall mounting. Excluding bracket.

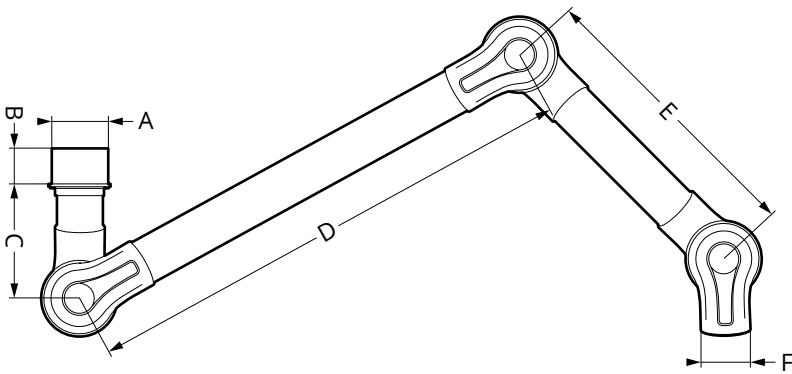

Article	Version				Dimensions (mm)							Weight (kg)			
	STD	PP	ESD	ATEX	A	B	C	D	E	F	Lenght	STD	PP	ESD	ATEX
MET 650-50*	●		●	■	Ø98,5	80	250	300		Ø50	650	1,0		1,1	■
MET 750-50*	●		●	■	Ø98,5	80	250	450		Ø50	750	1,1		1,2	■
MET 1000-50	●		●	■	Ø98,5	80	250	400	300	Ø50	1000	1,5		1,6	■
MET 1300-50	●		●	■	Ø98,5	80	250	550	450	Ø50	1300	1,6		1,8	■
MET 1500-50	●		●	■	Ø98,5	80	250	750	450	Ø50	1500	1,9		1,9	■
MET 1000-75	●	●	●	■	Ø98,5	80	250	400	300	Ø75	1000	2,1	1,8	2,3	■
MET 1300-75	●	●	●	■	Ø98,5	80	250	550	450	Ø75	1300	2,5	2,0	2,5	■
MET 1500-75	●	●	●	■	Ø98,5	80	250	750	450	Ø75	1500	2,7	2,2	2,7	■
MET 2000-75	●		●	■	Ø98,5	80	250	1000	650	Ø75	2000	3,2			■
METS 1500-75**	●	●	●	■	Ø98,5	80	250	750	450	Ø75	1500	3,3	2,8	3,3	■
METS 2000-75**	●	●	●	■	Ø98,5	80	250	1000	650	Ø75	2000	3,7	3,0	3,7	■
MET 1150-100	●	●		■	Ø125	135	260	450	350	Ø100	1150	4,5	4,0		■
MET 1350-100	●	●		■	Ø125	135	260	550	450	Ø100	1350	4,7	4,2		■
MET 1650-100**	●	●		■	Ø125	135	260	750	550	Ø100	1650	5,8	5,0		■
MET 1900-100**	●	●		■	Ø125	135	260	1000	550	Ø100	1900	6,2	5,2		■
MET 2100-100***	●	●		■	Ø125	135	260	1000	750	Ø100	2100	6,8	5,7		■
MET 2650-100***	●	●		■	Ø125	135	260	1300	1000	Ø100	2650	7,6	6,2		■

* Two joints.

** Including external gas spring.

*** Including two external gas springs.

MEB (Table)

With an internal mechanical spring or external gas spring (depending on model), for table mounting.

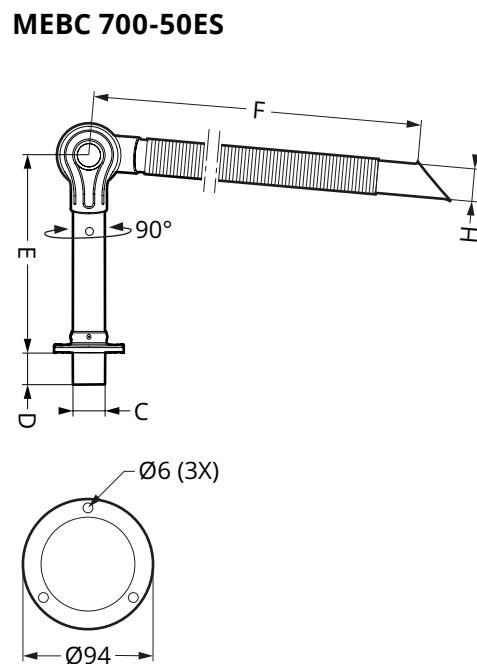
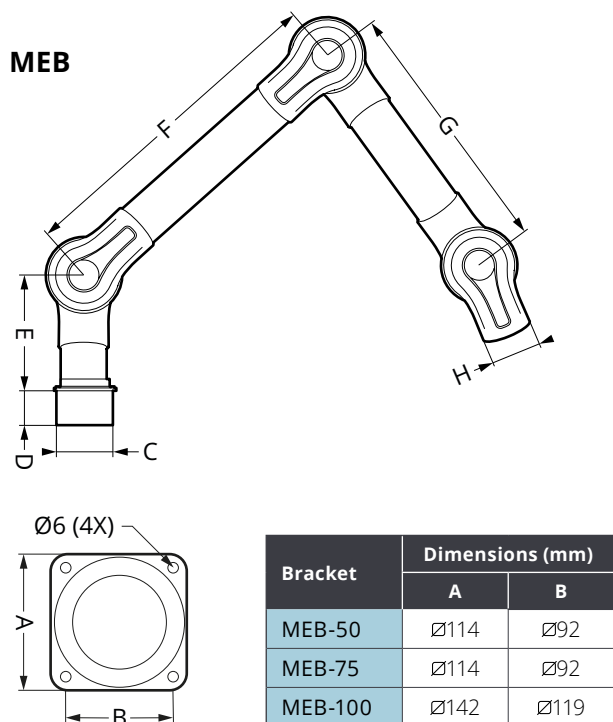

Article	Version				Dimensions (mm)							Weight (kg)			
	STD	PP	ESD	ATEX	C	D	E	F	G	H	Length	STD	PP	ESD	ATEX
MEB 650-50*	●		●	■	Ø98,5	80	250	300		Ø50	650	1,0		1,1	■
MEBC 700-50ES**	●		●	■	Ø52,5	60	335	600		Ø50	700			0,9	■
MEB 750-50*	●		●	■	Ø98,5	80	250	450		Ø50	750	1,1		1,2	■
MEB 1000-50	●		●	■	Ø98,5	80	250	400	300	Ø50	1000	1,5		1,6	■
MEB 1300-50	●		●	■	Ø98,5	80	250	550	450	Ø50	1300	1,6		1,8	■
MEB 1500-50	●		●	■	Ø98,5	80	250	750	450	Ø50	1500	1,9		1,9	■
MEB 1000-75	●	●	●	■	Ø98,5	80	250	400	300	Ø75	1000	2,1	1,8	2,3	■
MEB 1300-75	●	●	●	■	Ø98,5	80	250	550	450	Ø75	1300	2,5	2,0	2,5	■
MEB 1500-75	●	●	●	■	Ø98,5	80	250	750	450	Ø75	1500	2,7	2,2	2,7	■
MEB 1150-100	●	●		■	Ø125	135	260	450	350	Ø100	1150	4,5	4,0		4,3
MEB 1350-100	●	●		■	Ø125	135	260	550	450	Ø100	1350	4,7	4,2		4,6
MEB 1650-100***	●	●		■	Ø125	135	260	750	550	Ø100	1650	5,8	5,0		5,4
MEB 1900-100***	●	●		■	Ø125	135	260	1000	550	Ø100	1900	6,2	5,2		5,6

* Two joints.

** One joint with Flexible suction nozzle (MEFS 600-50ES) fitted.

*** Including external gas spring.

Brackets

FUMEX ME's ceiling and wall brackets are designed for maximum stability with a stylish design. The special extruded anodised aluminium profiles have a unique concave design specially adapted to ensure perfect function and professional installation. No joints regardless of length, and great flexibility for special adjustments. The brackets are available in different versions to suit all ME designs.

Versions

Standard: Anodised aluminium, powder-coated metal parts (white), polypropylene duct connection.

L (painted externally): Aluminium and metal parts painted externally (white), polypropylene duct connection.

IL (painted internally/externally for greater corrosion resistance): Aluminium and metal parts painted internally and externally (white), polypropylene duct connection. Max. length: 1.25 m.

ESD (ES): Anodised aluminium, powder-coated metal parts (white), conductive polypropylene duct connection. Approved in accordance with EN 61340-5-1.

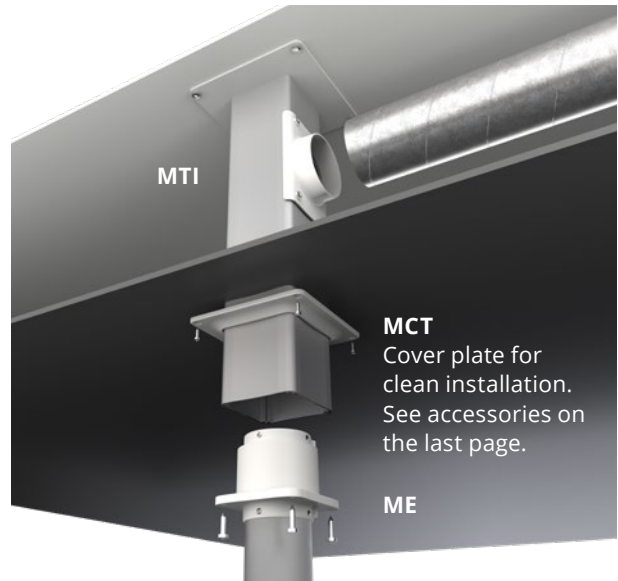

ATEX (EX): Aluminium and metal parts painted using special conductive paint (black), conductive polypropylene duct connection. Earth cable for safe grounding. Complies with the ATEX Directive 2014/34/EU category 2 gases and dust.

Ceiling bracket MTI

The ceiling bracket functions as an exhaust duct so you avoid costly external duct routing and extra drilling through the suspended ceiling. Simple, stable and clean installation. On request, MTI can be supplied in lengths exceeding 2 m.

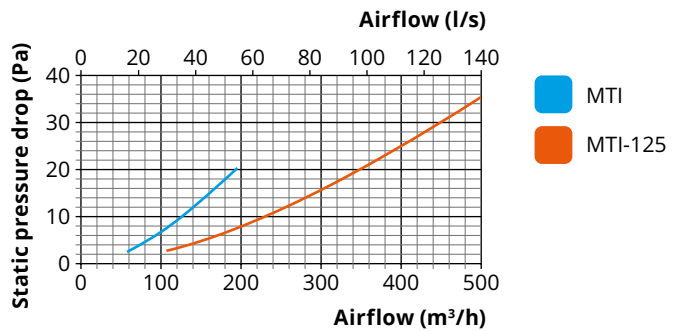
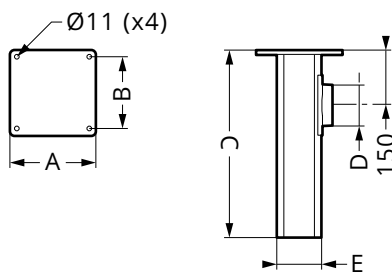

ME 50/75	Dimensions (mm)					Weight (kg)				
	Article	A	B	C	D	E	STD	PP	ESD	ATEX
MTI 250	Ø200	Ø180	250	Ø98,5	Ø107	2,3		2,3	2,5	
MTI 500	Ø200	Ø180	500	Ø98,5	Ø107	3,0		3,0	3,2	
MTI 750	Ø200	Ø180	750	Ø98,5	Ø107	3,6		3,6	3,8	
MTI 1000	Ø200	Ø180	1000	Ø98,5	Ø107	4,2		4,2	4,4	
MTI 1250	Ø200	Ø180	1250	Ø98,5	Ø107	5,0		5,0	5,2	
MTI 1500	Ø200	Ø180	1500	Ø98,5	Ø107	5,6		5,6	5,8	
MTI 1750	Ø200	Ø180	1750	Ø98,5	Ø107	6,4		6,4	6,6	
MTI 2000	Ø200	Ø180	2000	Ø98,5	Ø107	7,0		7,0	7,2	

ME 100	Dimensions (mm)					Weight (kg)				
	Article	A	B	C	D	E	STD	PP	ESD	ATEX
MTI 500-125	Ø250	Ø220	500	Ø125	Ø134	4,5				4,7
MTI 750-125	Ø250	Ø220	750	Ø125	Ø134	6,7				6,9
MTI 1000-125	Ø250	Ø220	1000	Ø125	Ø134	7,7				7,9
MTI 1250-125	Ø250	Ø220	1250	Ø125	Ø134	8,3				8,5
MTI 1500-125	Ø250	Ø220	1500	Ø125	Ø134	9,7				9,9
MTI 1750-125	Ø250	Ø220	1750	Ø125	Ø134	10,6				10,9
MTI 2000-125	Ø250	Ø220	2000	Ø125	Ø134	11,6				11,9



Ceiling bracket **MTF**

Ceiling bracket for mounting through e.g. floor structure with duct connection at the top. The attachment plate is adjustable along the entire length of the aluminium tube. If required, the aluminium profile can be cut during fitting.

Article	Dimensions (mm)				Weight (kg)			
	A	B	C	D	STD	PP	ESD	ATEX
MTF 1000 (ME 50/75)	Ø200	Ø180	Ø98,5	Ø107	4,4		4,4	4,5
MTF 1000-125 (ME 100)	Ø250	Ø220	Ø125	Ø134	6,4			6,5

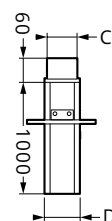
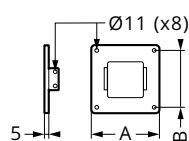

Wall bracket **MVK**

For special orders, wall bracket length can be customised both horizontally and vertically.

Article	Dimensions (mm)				Weight (kg)			
	A	B	C	D	STD	PP	ESD	ATEX
MVK (ME 50/75)	Ø98,5	219	65	125	2,3		2,3	2,3
MVK-125 (ME 100)	Ø125	232	60	150	2,6			2,7

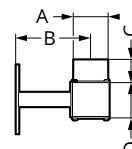
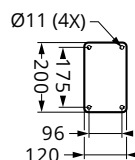

Flexible table bracket **MBF**

Flexible bracket for attachment to a tabletop or shelf. Supplied complete with two screw clamps. Also available in ESD/ATEX version.

Article	Weight (kg)			
	STD	PP	ESD	ATEX
MBF	0,8		0,8	0,8
MBFCES*	0,8		0,8	

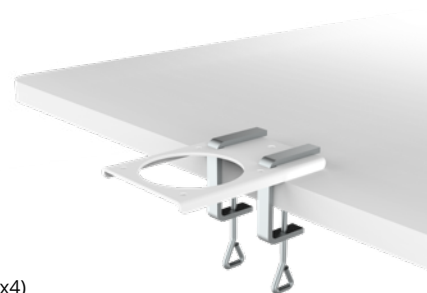
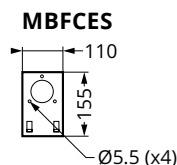
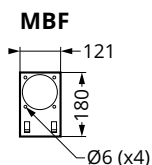

* Only suitable for MEBC 700-50ES; see table on page 11 for version.

Hoods and suction nozzles

DOME HOOD MEK

Suitable for gases with high lift, completely or partially covering the contaminant source without obscuring the view. Temp. range: -15 °C to +80 °C.

Model	Material (hood)	Colour
STD:	PMMA	Transparent
PP:	PP	Transparent (MEK 350/351) Opaque (MEK 500)
ESD/ATEX:	PP (MEK 350/351) / PE (MEK 500)	Black

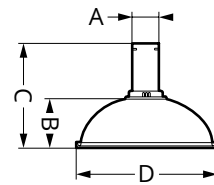

Article	Dimensions (mm)				Weight (kg)			
	A	B	C	D	STD	PP	ESD	ATEX
MEK 350-50	Ø50	135	255	Ø350	0,5		0,6	
MEK 350-75	Ø75	120	255	Ø350	0,5	0,4	0,6	0,6
MEK 351-100	Ø100	110	295	Ø350	0,7	0,5		0,6
MEK 500-100	Ø100	180	360	Ø500	1,1	0,8		1,0

SQUARE HOOD MESH

Suitable for positioning above gases with high lift or adjacent to the work surface for contaminants with no lift or low lift. All without obstructing the work. Temp. range: -15 °C to +80 °C.

Model	Material	Colour
STD:	PETG	Transparent

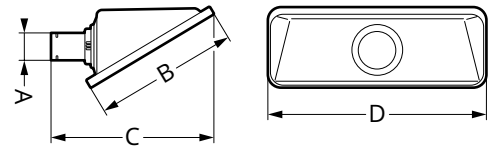

Article	Dimensions (mm)				Weight (kg)			
	A	B	C	D	STD	PP	ESD	ATEX
MESH 350-50	Ø50	310	400	360	0,6			
MESH 350-75	Ø75	310	400	360	0,7			
MESH 500-100	Ø100	470	590	560	1,3			

FLAT SCREEN HOOD MEPH

Designed to maximise the work area without obscuring the object from the user. The flat screen hood gives the best suction effect for table and bench work. Temp. range: -15 °C to +80 °C.

Model	Material	Colour
STD:	PETG	Transparent
PP:	PP	Opaque
ESD/ATEX:	PE (dissipative)	Black

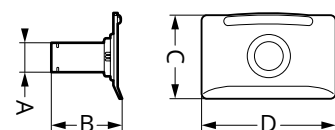

Article	Dimensions (mm)				Weight (kg)			
	A	B	C	D	STD	PP	ESD	ATEX
MEPH 300-50	Ø50	150	195	300	0,3		0,3	
MEPH 300-75	Ø75	150	195	300	0,4	0,3	0,3	0,3
MEPH 375-100	Ø100	200	250	375	0,6	0,4		0,5



METAL HOOD **MEM**

For work in harsher environments. Capture of hot gases, dust and similar. Can be fitted with work lighting* (MEMB). Temp. range: -15 °C to +80 °C.

Model	Material	Colour
STD/PP:	Al	White
ESD/ATEX:	Al	Black

MEMB - Technical data			
Output:	5 W	at 350 mA
Light flux:	100 lm	
Colour temperature:4,000 K	

* Only suitable for ME STD/PP.

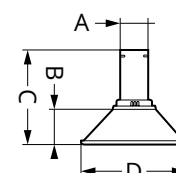

Article	Dimensions (mm)				Weight (kg)			
	A	B	C	D	STD	PP	ESD	ATEX
MEM 250-50	Ø50	70	215	Ø250	0,3		0,3	
MEM 250-75	Ø75	70	215	Ø250	0,4	0,3	0,3	0,3
MEM 251-100	Ø100	90	260	Ø250	0,6			0,5

SUCTION NOZZLE **MES**

For harsh environments and for getting close to the source of contamination without disrupting the work. Temp. range: -15 °C to +80 °C.

Model	Material	Colour
STD:	Al	None
PP:	PP	White
ESD/ATEX:	PE (dissipative)	Black

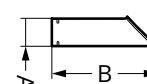

Article	Dimensions (mm)		Weight (kg)			
	A	B	STD	PP	ESD	ATEX
MES 300-50	Ø50	225	0,1		0,1	
MES 300-75	Ø75	225	0,2	0,1	0,1	0,1
MES 300-100	Ø100	225	0,3			

FLEXIBLE SUCTION NOZZLE **MEFS**

Designed to maximise mobility and flexibility without compromising on efficiency. Temp. range: -15 °C to +80 °C.

Model	Material	Colour
ESD:	ABS/PS (dissipative)	Black

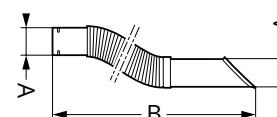

Article	Dimensions (mm)		Weight (kg)			
	A	B	STD	PP	ESD	ATEX
MEFS 600-50ES	Ø50	600			0,4	
MEFS 600-75ES	Ø75	600			0,5	

Accessories

PROTECTIVE GRILLE **MESG**

Stainless steel protective grille (EN 1.4436, AISI/UNS 316) to prevent objects from being sucked into the system. Fitted to joints. Temp. range: -15 °C to +80 °C.

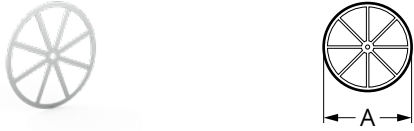

Article	Dimensions (mm)		Version			
	A		STD	PP	ESD	ATEX
MESG-50	Ø90		●		●	
MESG-75	Ø113.5		●		●	●
MESG-100	Ø163		●		●	●

REDUCING SLEEVE **MRM***

Polypropylene reducer, suitable for Ø 98.5 mm standard attachment, for reducing down to Ø50/75 mm.



Article	Dimensions (mm)		Version			
	A	B	STD	PP	ESD	ATEX
MRM 100-50	Ø50	90	●	●	●	●
MRM 100-75	Ø75	60	●	●	●	●

* Only suitable for ME 50/75

COVER PLATE **MCT**

Polypropylene cover plate for stylish installation, used together with MTI ceiling bracket for stabilisation and to cover lead throughs in suspended ceilings.



Article	Dimensions (mm)			Version			
	A	B	C	STD	PP	ESD	ATEX
MCT	Ø148	Ø170	13	●	●	●	●
MCT-125	Ø188	Ø212	15	●	●	●	●

Delivery version

Supplied assembled for easy installation. Hood and bracket ordered separately.

Always choose a low pressure drop

A low pressure drop always saves energy. A low pressure drop also produces less noise, reduces the risk of annoying ventilation sounds and can more easily be combined with other extractors in the same system.