

# ELFÖRBINDNINGSSCHEMA SYSTEM 1:3, 1-FAS

0911

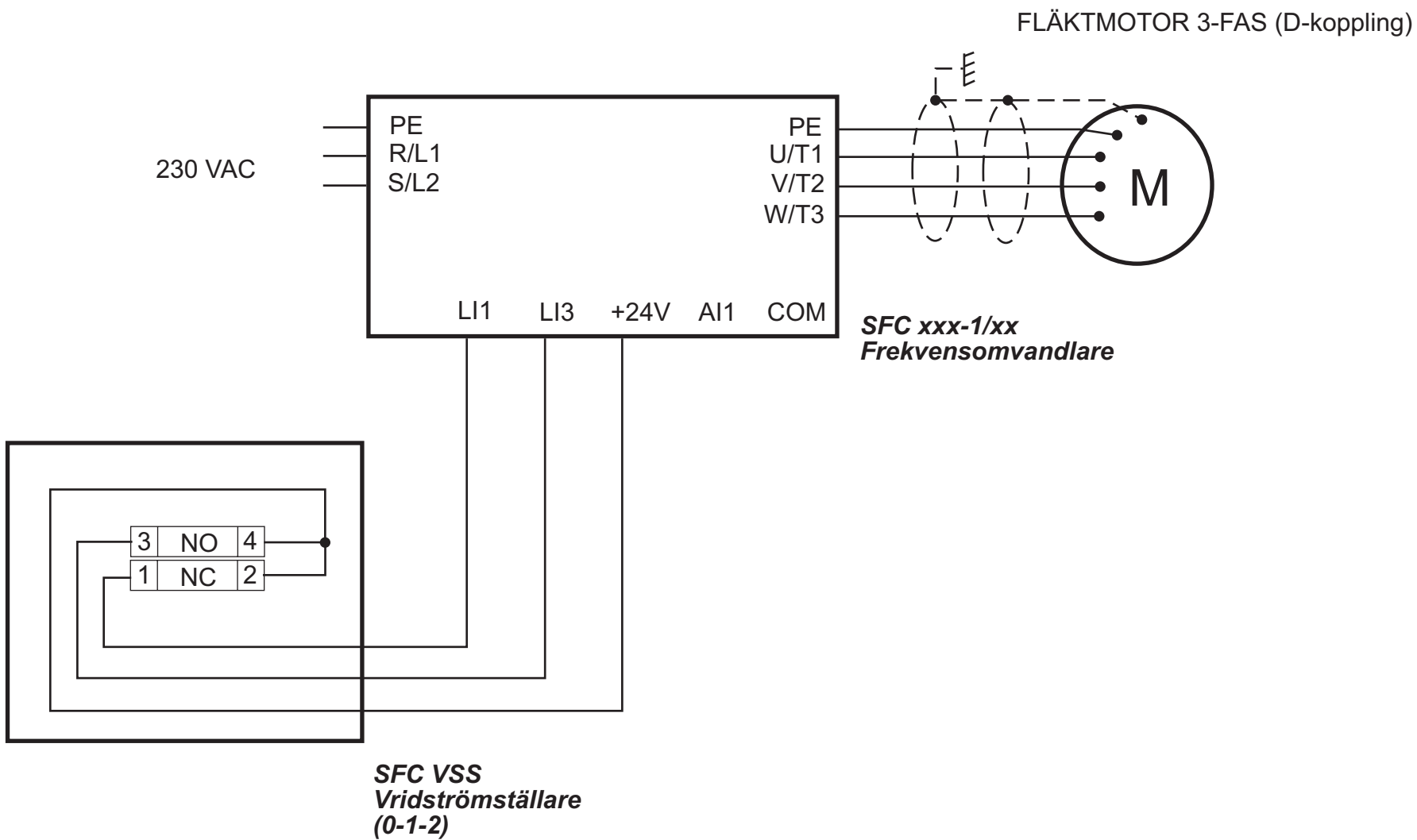

# CONNECTION DRAWING SYSTEM 1:3, 1-PHASE

0911

