

# ELFÖRBINDNINGSSCHEMA SYSTEM 4:1, 1-FAS

0913

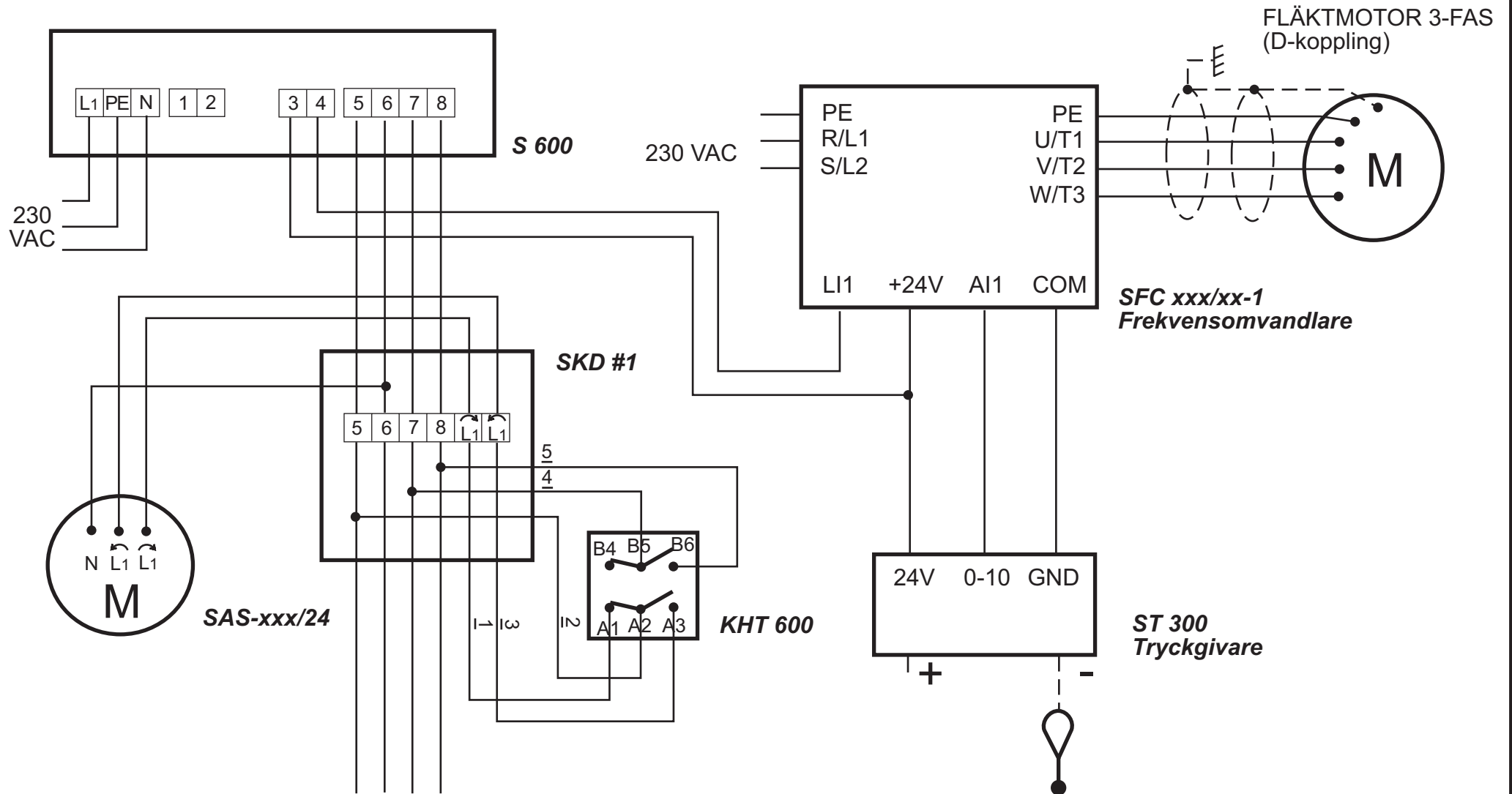

# CONNECTION DRAWING SYSTEM 4:1, 1-PHASE

0913

