

# ELFÖRBINDNINGSSCHEMA SYSTEM 1:4, 3-FAS

1838

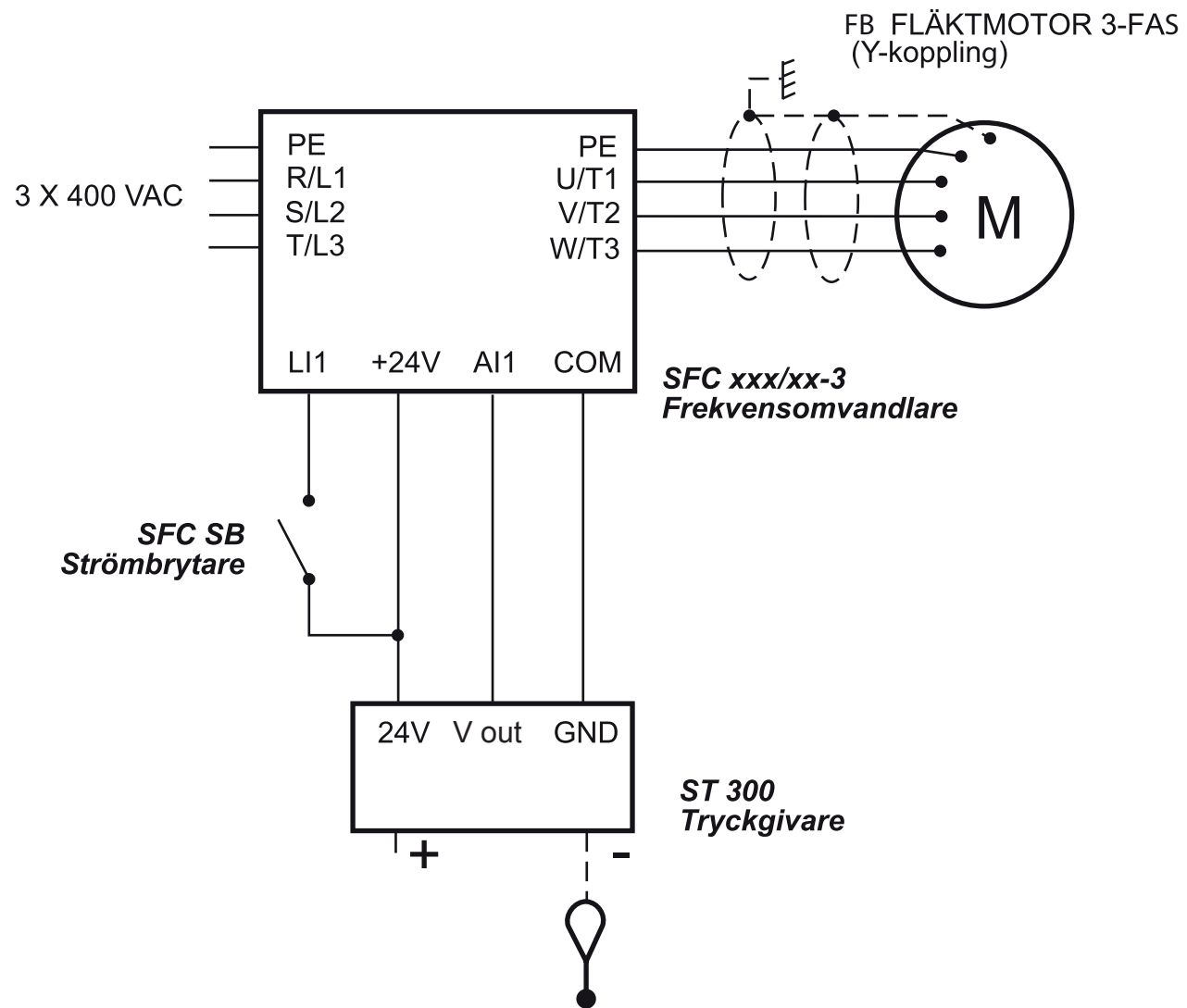

# CONNECTION DRAWING SYSTEM 1:4, 3-PHASE

1838

