

ELFÖRBINDNINGSSCHEMA SYSTEM 4:2, 3-FAS

1647

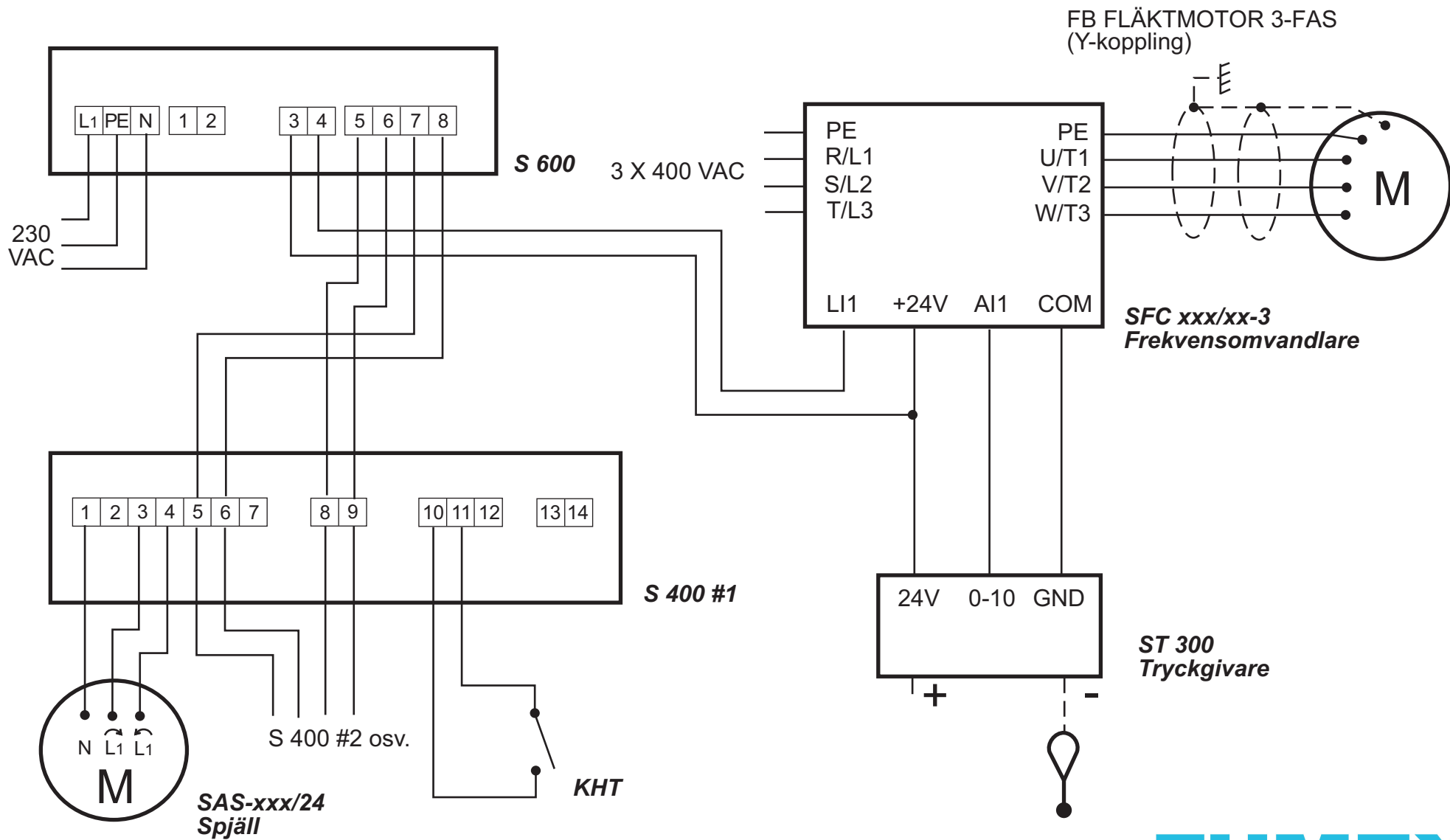

CONNECTION DRAWING SYSTEM 4:2, 3-PHASE

1647

