

ELFÖRBINDNINGSSCHEMA SYSTEM 4:11

1046

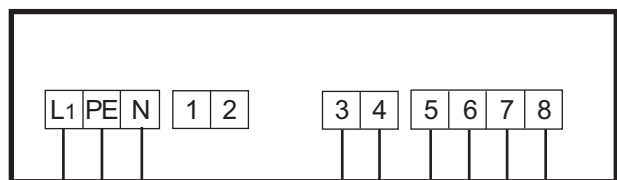

230 VAC

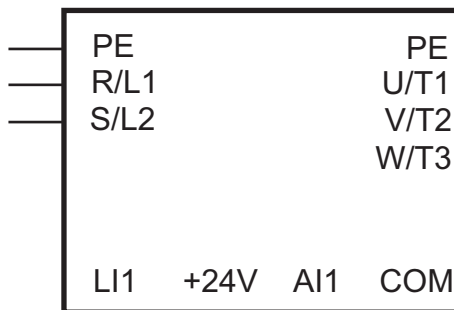

FLÄKTMOTOR 3-FAS
(D-koppling)

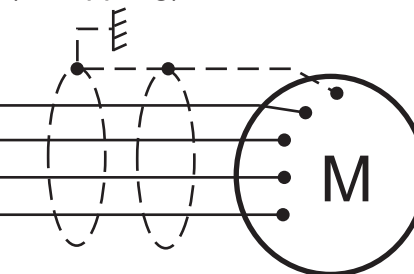

230 VAC

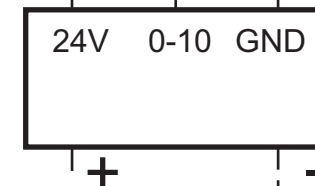
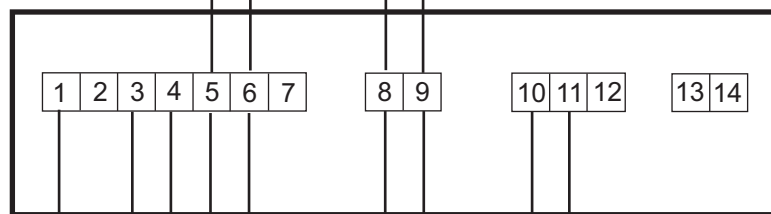

Schema APS 955

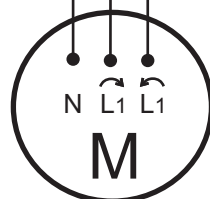
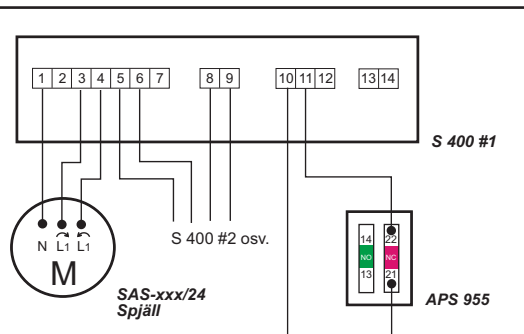

S 400 #2 osv.

SAS-xxx/24
Spjäll

Copyright Fumex AB 2010

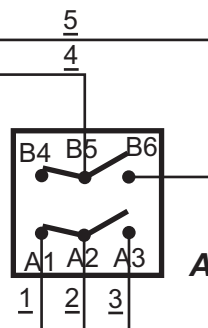

FUMEX®

CONNECTION DRAWING SYSTEM 4:11

1046

FAN MOTOR 3-PHASE
(D-wiring)

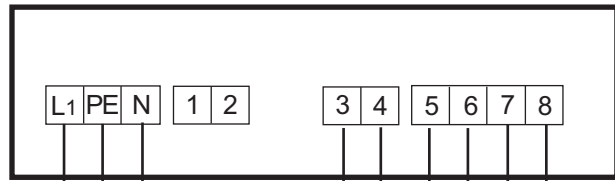

230 VAC

230 VAC

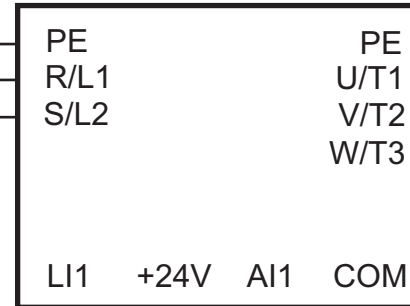

SFC xxx/xx-1
Frequency converter

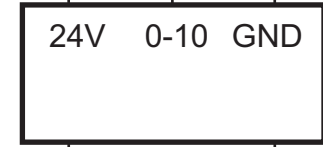

ST 300
Pressure
transmitter

Drawing APS 955

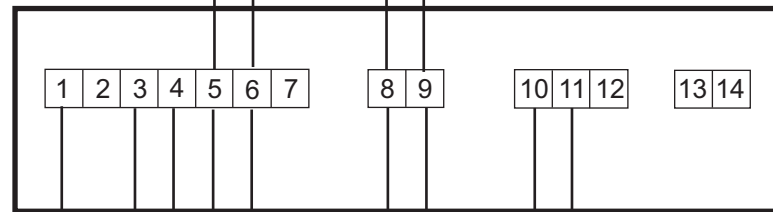
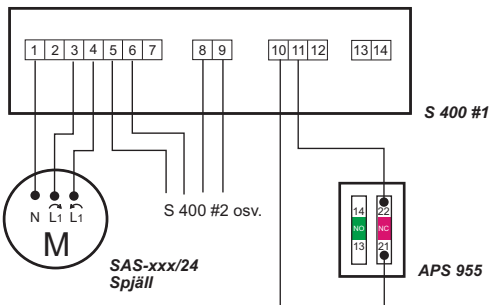

S 400 #1

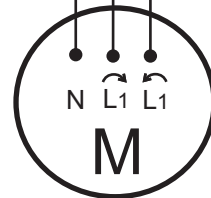

S 400 #2 osv.

SAS-xxx/24
Damper

Copyright Fumex AB 2010

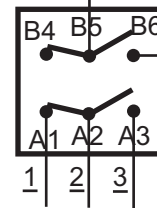

FUMEX[®]